

$\mathcal{O}(\alpha)$ Monte Carlo for WW process

S. JADACH

Institute of Nuclear Physics, Kraków, Poland
and CERN-TH

- Introduction
- WW physics with YFSWW/KoralW
- Exponentiation for Charged Instable Particles
- Polish node

LEP2 Needs $\mathcal{O}(\alpha)$ corrections!

The $\mathcal{O}(\alpha^1)$ genuine EW corrections $\sim 1\%$ at 200GeV

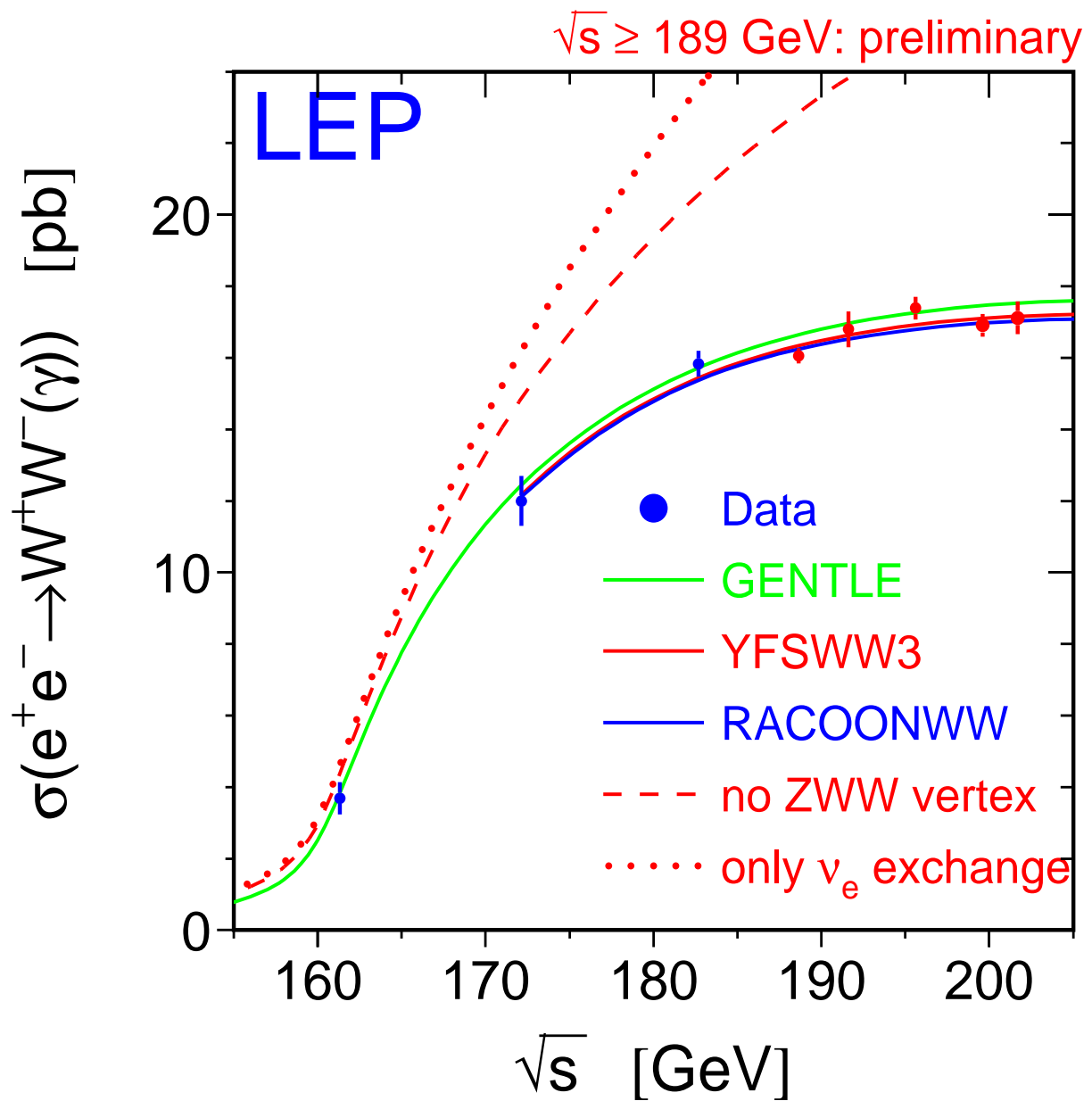

WW physics with YFSWW3 and KORALW**Papers:**

- YFSWW3:** Phys. Rev. **D54** (1996) 5434;
Phys. Lett. **B417** (1998) 326;
Phys. Rev. **D61** (2000) 113010;
hep-ph/0007012; CERN-TH/2001-017
- KoralW:** Comput. Phys. Commun. **94** (1996) 215;
Phys. Lett. **B372** (1996) 289;
Comput. Phys. Commun. **119** (1999) 272;
CERN-TH/2001-102.

Authors of YFSWW3 and KoralW:

S. JADACH, W.P., M. SKRZYPEK, B.F.L. WARD, Z. WĄS

YFS3WW includes $\mathcal{O}(\alpha)$ EW corrections by
J. Fleisher, F. Jegerlehner, K. Kołodziej and M. Zrałek

Combining YFSWW3 and KoralW, *very schematically*

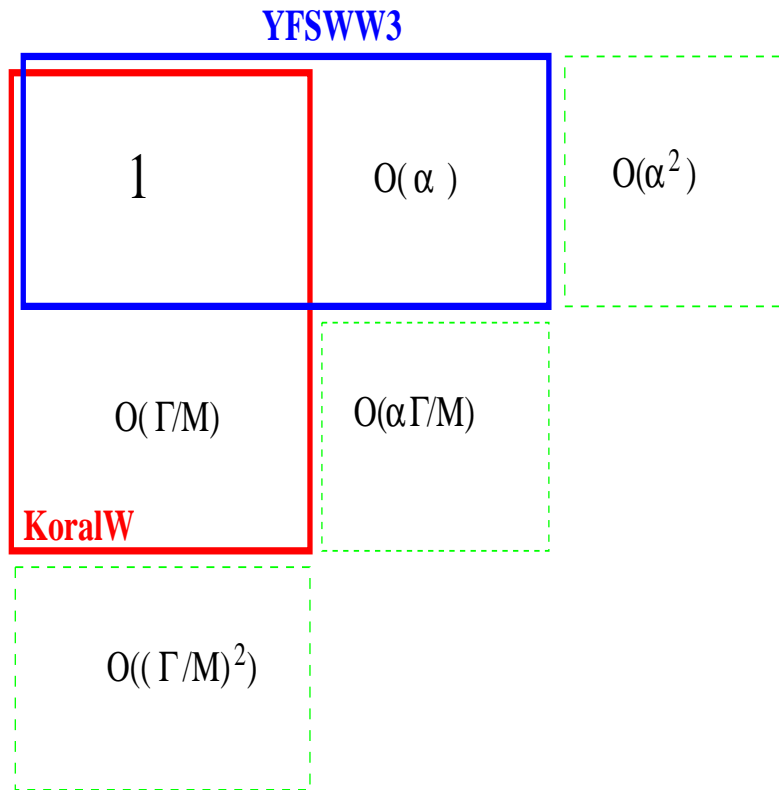

Green boxes represent neglected $< 0.1\%$ contributions.
 However, QED ISR is however included up to $\mathcal{O}(\alpha^3)$ in LL,
 and KoralW includes all background.

⇒ **EXPERIMENTALLY:**

W-pairs observed through **4f** final states + **radiative photons**

● **GENERAL PROCESS:**

$$e^+ + e^- \longrightarrow f_1 + \bar{f}_2 + f_3 + \bar{f}_4 + n\gamma, \quad (n = 0, 1, \dots)$$

⇒ **THEORETICALLY:** also **EW LOOP** corrections necessary!

● **Exclusive Yennie-Frautschi-Suura Exponentiation:**

$$\begin{aligned} \sigma = & \sum_{n=0}^{\infty} \frac{1}{n!} \int \prod_{j=1}^4 \frac{d^3 q_j}{q_j^0} \left\{ \prod_{i=1}^n \frac{d^3 k_i}{k_i^0} \tilde{S}(\{p\}, \{q\}, k_i) \Theta \left(\frac{2k_i^0}{\sqrt{s}} - \epsilon \right) \right\} \\ & \times \delta^{(4)} \left(p_1 + p_2 - \sum_{j=1}^4 q_j - \sum_{i=1}^n k_i \right) e^{Y(\{p\}, \{q\}; \epsilon)} \\ & \times \left[\bar{\beta}_0^{(m)}(\{p\}, \{q\}) + \sum_{i=1}^n \frac{\bar{\beta}_1^{(m)}(\{p\}, \{q\}, k_i)}{\tilde{S}(\{p\}, \{q\}, k_i)} + \dots \right], \end{aligned}$$

where

$\tilde{S}(\{p\}, \{q\}, k)$ — Soft Photon Radiation Factor

$Y(\{p\}, \{q\}; \epsilon)$ — YFS FormFactor

$\bar{\beta}_n^{(m)}(\dots)$ — $\mathcal{O}(\alpha^m)$ YFS Residuals for n Real Photons

EW loop corrections enter through $\bar{\beta}$'s.

⇒ More Details:

TWO MC EVENT GENERATORS



YFSWW

Simplified Process
(Double-Resonant W)



KORALW

Full Process
(All 4f Channels)



As Much Rad. Corr.
As Possible (Needed)



Simplified Rad. Corr.
(ISR, Coulomb, ...)

δ_{WW}^{NL}

- * $\mathcal{O}(\alpha)$ NL EW Corr.
- * "Screened" Coul. Corr.
- (Approximation For
Non-Factorizable Corr.)

WW-Process

- * YFS $\mathcal{O}(\alpha^3)$ LL ISR
- * Coulomb Correction
- * "Naive" QCD Corr.
- * Full CKM Matrix
- * W-BR's Incl. Rad Corr.
- * Anomalous TGC's
- * FSR by PHOTOS
- * τ Decays by TAUOLA
- * Hadronization by JETSET
- * Semi-An. Code: KORWAN

δ_{4f}

- * Non-WW 4f Contrib.
- * YFS $\mathcal{O}(\alpha^3)$ LL ISR

⇒ TWO POSSIBILITIES:

1. $\sigma_{Y/K} = \sigma_Y \oplus \delta_{4f}$ ← For WW-Physics
2. $\sigma_{K/Y} = \sigma_K \oplus \delta_{WW}^{NL}$ ← When $\delta_{4f} > \delta_{WW}^{NL}$

NEW! Concurrent realization of $\sigma_{K/Y}$, NEW!

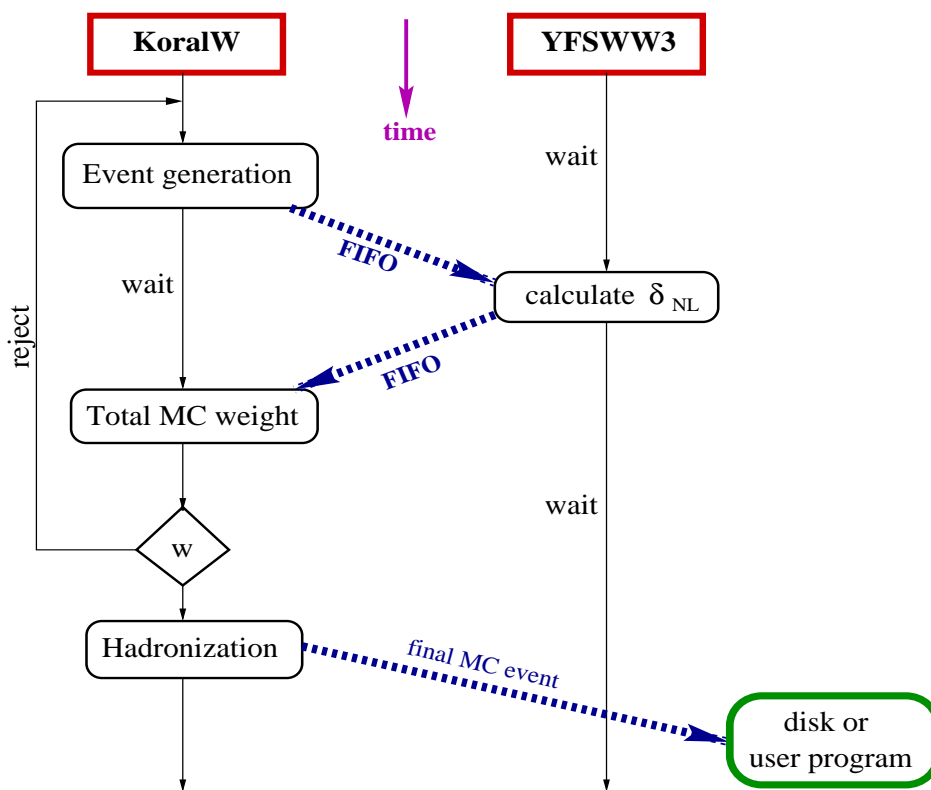

Works effectively as a single MC event generator

$\frac{\Gamma_W}{M_W} \sim \frac{1}{40}$ is important expansion parameter!

More on WW Physics With YFSWW3

Double-Resonant Feynman Graphs (CC03)

Non Gauge-Invariant!

⇒ POSSIBLE SOLUTION:

Leading Pole Approximation (LPA):

- Matrix Element (For Gauge-Invariant Set of Feynman Graps)
Can Be Decomposed:

$$\mathcal{M} = \sum_i T_i(\dots, p_j, \dots, p_k, \dots) M_i(\dots, p_j \cdot p_k, \dots)$$

T_i ← Spinor and Lorentz Tensor Structure of M.E.
(External Wave Functions, etc.)

M_i ← Lorentz Scalar Functions
(e.g. Describe Finite-Range W-Propagation)

⇒ TWO APPROACHES:

a) R. G. Stuart, Nucl. Phys. **B498** (1997) 28 and Refs. therein

M_i Expanded About Complex Poles (Laurent Series)
Corresponding to Unstable Particles (Here: W's)

T_i Untouched by Laurent Expansion!

→ LPA: Only Leading-Pole Terms Kept!

IMPLEMENTED IN YFSWW: LPA_a ← RECOMMENDED

b) Yellow Report CERN 96-01, Vol. 1, p. 79 and Refs. therein^a

The Whole Matrix Element \mathcal{M} Expanded About Poles!
(Connection to On-Shell WW Production and Decay)

→ LPA: Only Leading-Pole Terms Kept!

IMPLEMENTED IN YFSWW: LPA_b ← For Tests

● NUMERICAL DIFFERENCES :

Level	$LPA_a/LPA_b - 1$
Born	Several Per Cent
δ_{ISR}	A Few Per Mille
δ_{WW}^{NL}	$\leq 0.1\%$

⇒ Born: LPA_a Very Close to CC11 (Min. Gauge-Invariant Set of Feynman Diagrams)

^aSee also: W. Beenakker, F.A. Berends and A.P. Chapovsky, Nucl. Phys. **B548** (1999) 3

YFSWW3-1.14 \leftrightarrow KORALW-1.42

(CC09/CC10/CC11 Channels)

$\sqrt{s} = 161 \text{ GeV}$		$\sigma_{WW} [fb]$		$\delta_{4f} [\%]$		$\delta_{WW}^{NL} [\%]$
Final state	Program	Born	ISR	Born	ISR	
$u\bar{d}\mu^-\bar{\nu}_\mu$	YFSWW	156.670 (16)	122.832 (08)	—	—	-1.41 (4)
	KORALW	156.601 (24)	122.836 (11)	0.29	0.25	—
	(Y-K)/Y	0.04 (2)%	0.00 (1)%	—	—	—

$\sqrt{s} = 200 \text{ GeV}$		$\sigma_{WW} [fb]$		$\delta_{4f} [\%]$		$\delta_{WW}^{NL} [\%]$
Final state	Program	Born	ISR	Born	ISR	
$\nu_\mu\mu^+\tau^-\bar{\nu}_\tau$	YFSWW	219.793 (16)	204.198 (09)	—	—	-1.92 (4)
	KORALW	219.766 (26)	204.178 (21)	0.041	0.044	—
	(Y-K)/Y	0.01 (1)%	0.01 (1)%	—	—	—
$u\bar{d}\mu^-\bar{\nu}_\mu$	YFSWW	659.69 (5)	635.81 (3)	—	—	-1.99 (4)
	KORALW	659.59 (8)	635.69 (7)	0.073	0.073	—
	(Y-K)/Y	0.02 (1)%	0.02 (1)%	—	—	—
$u\bar{d}s\bar{c}$	YFSWW	1978.37 (14)	1978.00 (09)	—	—	-2.06 (4)
	KORALW	1977.89 (25)	1977.64 (21)	0.060	0.061	—
	(Y-K)/Y	0.02 (1)%	0.02 (1)%	—	—	—

$\sqrt{s} = 500 \text{ GeV}$		$\sigma_{WW} [fb]$		$\delta_{4f} [\%]$		$\delta_{WW}^{NL} [\%]$
Final state	Program	Born	ISR	Born	ISR	
$u\bar{d}\mu^-\bar{\nu}_\mu$	YFSWW	261.368 (23)	292.029 (18)	—	—	-4.95 (4)
	KORALW	261.348 (17)	291.979 (19)	-0.51	-0.51	—
	(Y-K)/Y	0.01 (1)%	0.02 (1)%	—	—	—

δ_{WW}^{NL} Much Bigger Than δ_{4f} !

YFSWW3-1.14 \leftrightarrow KORALW-1.42

$$e^+e^- \longrightarrow W^+W^- \longrightarrow u\bar{d}\mu^-\bar{\nu}_\mu$$

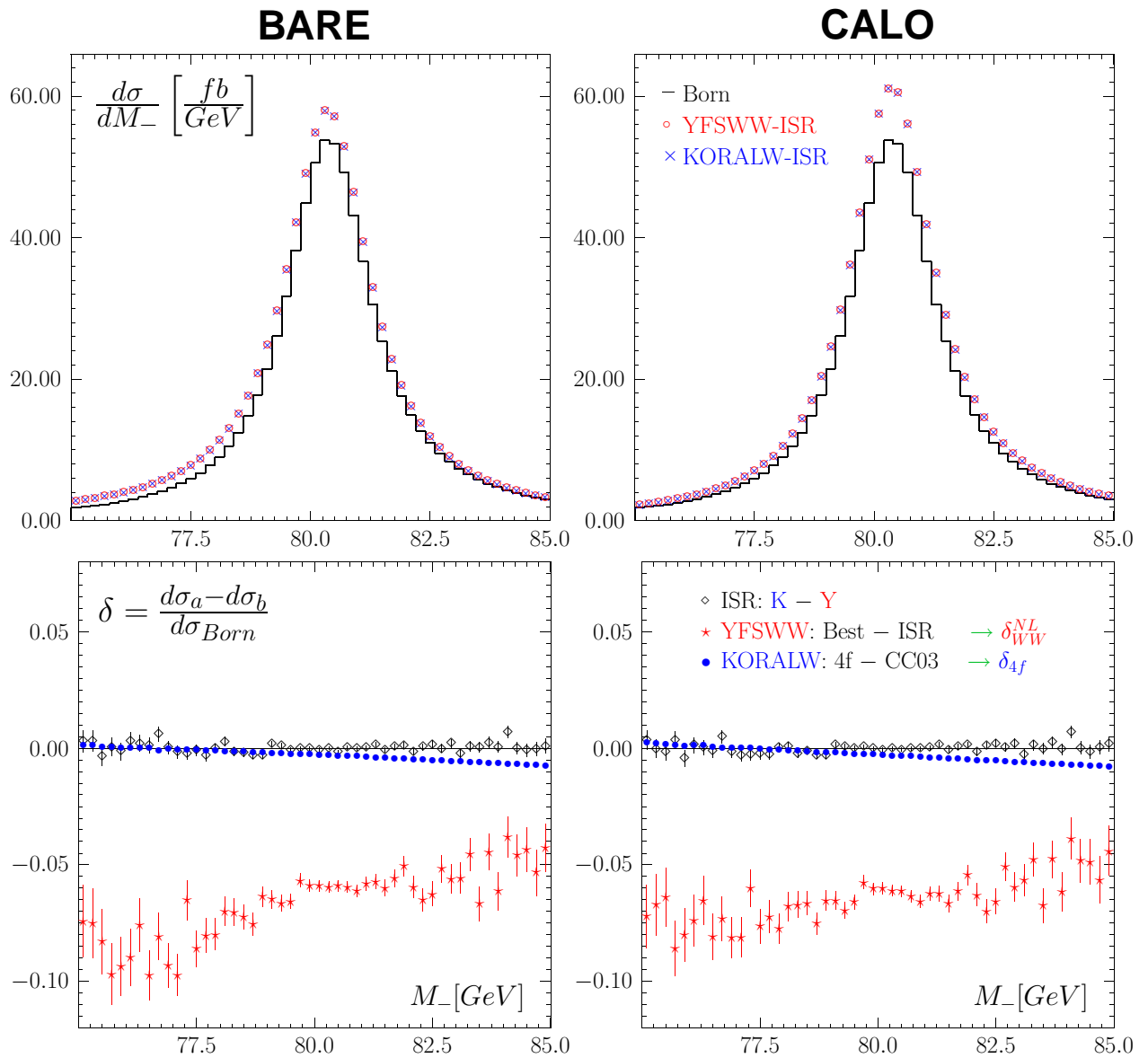

$M_{W^-}^{inv} @ \sqrt{s} = 500$ GeV

YFSWW3-1.14 \leftrightarrow RACOONWW A. Denner, S. Dittmaier,
M. Roth, D. Wackerath
@ LEP2 Energies

\sqrt{s} [GeV]	σ_{WW} [pb]		(Y - R)/Y [%]
	YFSWW3	RACOONWW	
168.000	9.8302 (34)	9.8392 (49)	-0.09 (6)
172.086	12.0988 (41)	12.0896 (76)	0.08 (7)
176.000	13.6360 (45)	13.6271 (66)	0.07 (6)
180.000	14.7791 (49)	14.7585 (72)	0.14 (6)
182.655	15.3610 (50)	15.3684 (76)	-0.05 (6)
185.000	15.7755 (48)	15.7716 (78)	0.25 (6)
188.628	16.2664 (53)	16.2486 (111)	0.11 (8)
191.583	16.5680 (57)	16.5188 (85)	0.30 (6)
195.519	16.8409 (61)	16.8009 (87)	0.24 (6)
199.516	17.0167 (68)	16.9791 (88)	0.22 (6)
201.624	17.0755 (62)	17.0316 (89)	0.26 (6)
205.000	17.1279 (55)	17.0792 (89)	0.28 (6)
208.000	17.1507 (67)	17.0942 (90)	0.33 (7)
210.000	17.1467 (66)	17.0858 (91)	0.34 (7)
215.000	17.0786 (70)	17.0378 (91)	0.24 (7)

Agreement Within 0.4%

Summer 2000 LEP2 Data

21/07/2000

LEP

Preliminary

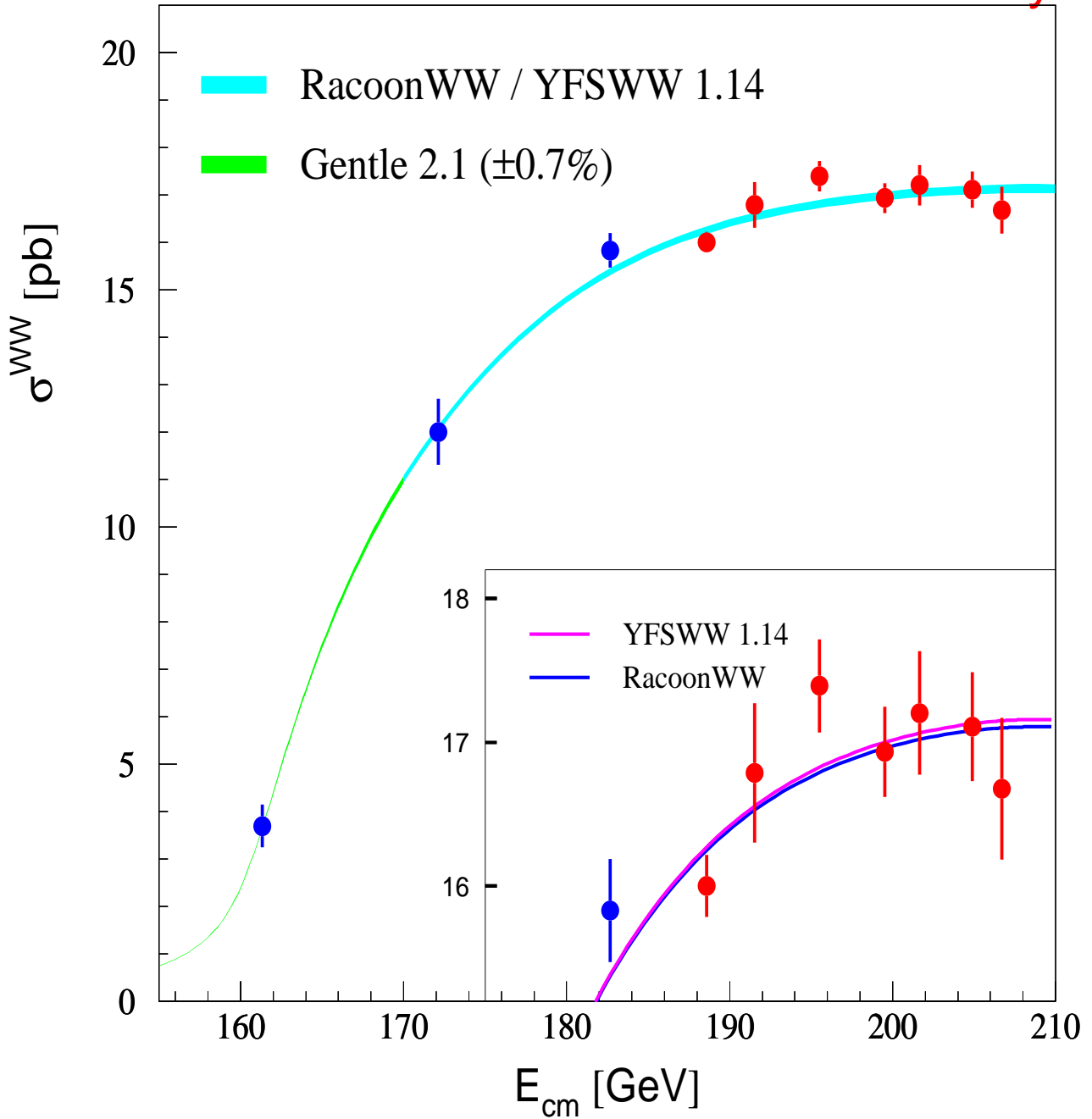

YFSWW3-1.14: Total WW xSect. including LC

\sqrt{s} [GeV]	σ_{WW} [pb]			$\frac{\text{ISR}-\text{Born}}{\text{Born}}$ [%]	$\frac{\text{Best}-\text{ISR}}{\text{Born}}$ [%]
	Born	ISR	Best		
155.000	0.94585 (17)	0.76497 (14)	0.75478 (35)	-19.12 (3)	-1.08 (5)
157.000	1.38578 (25)	1.10298 (19)	1.08686 (48)	-20.41 (3)	-1.16 (5)
159.000	2.30412 (40)	1.79141 (30)	1.76254 (80)	-22.25 (3)	-1.25 (5)
161.000	4.4138 (7)	3.3579 (5)	3.2969 (14)	-23.92 (3)	-1.38 (5)
163.000	7.3264 (10)	5.6178 (7)	5.5219 (22)	-23.32 (3)	-1.31 (4)
165.000	9.7343 (11)	7.6385 (9)	7.5073 (27)	-21.53 (3)	-1.35 (4)
167.000	11.5788 (14)	9.2903 (10)	9.1367 (31)	-19.76 (3)	-1.33 (4)
168.000	12.3391 (14)	10.0020 (11)	9.8302 (34)	-18.94(3)	-1.39 (4)
170.000	13.6124 (15)	11.2392 (12)	11.0504 (37)	-17.43 (3)	-1.39 (4)
172.086	14.6717 (16)	12.3114 (14)	12.0988 (41)	-16.09 (3)	-1.45 (4)
176.000	16.1293 (17)	13.8760 (15)	13.6360 (45)	-13.97 (3)	-1.49 (4)
180.000	17.1207 (18)	15.0325 (16)	14.7791 (49)	-12.20 (3)	-1.48 (4)
182.655	17.5852 (19)	15.6190 (17)	15.3610 (50)	-11.18 (3)	-1.47 (4)
185.000	17.8981 (19)	16.0422 (18)	15.7755 (48)	-10.37 (3)	-1.49 (4)
188.628	18.2391 (20)	16.5540 (18)	16.2664 (53)	-9.24 (3)	-1.58 (4)
191.583	18.4179 (20)	16.8649 (18)	16.5680 (57)	-8.43 (3)	-1.61 (4)
195.519	18.5466 (19)	17.1651 (19)	16.8409 (61)	-7.45 (3)	-1.75 (4)
199.516	18.5828 (19)	17.3608 (19)	17.0167 (68)	-6.58 (3)	-1.85 (4)
201.624	18.5696 (21)	17.4284 (19)	17.0755 (62)	-6.15 (3)	-1.90 (4)
205.000	18.5162 (21)	17.4968 (20)	17.1279 (55)	-5.51 (3)	-1.99 (4)
208.000	18.4399 (21)	17.5216 (20)	17.1507 (67)	-4.98 (3)	-2.01 (4)
210.000	18.3767 (21)	17.5219 (20)	17.1467 (66)	-4.65 (2)	-2.04 (4)
215.000	18.1833 (21)	17.4773 (20)	17.0786 (70)	-3.88 (2)	-2.19 (4)
250	16.2477 (16)	16.2293(14)	15.7952 (44)	-0.11 (2)	-2.67 (3)
350	11.3812 (12)	11.9325 (12)	11.5255 (39)	4.84 (2)	-3.58 (4)
500	7.3621 (8)	7.9823 (9)	7.6324 (30)	8.42 (2)	-4.75 (4)
750	4.2885 (6)	4.7993 (6)	4.5349 (21)	11.91 (2)	-6.17 (5)
1000	2.8598 (4)	3.2679 (4)	3.0543 (16)	14.27(2)	-7.47 (5)
1250	2.0714 (3)	2.4017 (4)	2.2263 (13)	15.95 (2)	-8.47 (6)
1500	1.5865 (2)	1.8615 (3)	1.7095 (11)	17.33 (2)	-9.58 (7)

 δ_{ISR}
 δ_{WW}^{NL}

The problem of photon emission from W 's**Problems and questions:**

- **Exponentiation for W 's does not make sense, because for W 's there are IR singularities!
Of course it does! W is almost stable particle!
See example of τ .**
- **Where is the truth? What is the mechanism?**
- **How big are QED interference between resonance production and decay?
The so called Non-Factorizable (NF) corrections.**
- **What are distributions of photons with $E_\gamma \sim \Gamma$?
All (except one) calculations of NF are inclusive.
Can one do fully exclusive MC calculation with NF interferences?**
- **Related question: How important is Coulomb effect?**

**Altogether there are about ~ 50 papers published on NF, although the net effect is $< 10MeV$ in terms of M_W .
Nevertheless, subject is very interesting theoretically.**

The following material is result of collaboration with W. Placzek and M. Skrzypek.

Basic facts

- Quite general argument: QED interferences between production and decay of instable particle are suppressed by Γ/M because of time separation.
- Since the effect is in $\mathcal{O}(\alpha)$, the net effect is $\mathcal{O}(\alpha\Gamma/M)$.
- The basic mechanism is that both real and virtual emissions are cut at $E_\gamma \sim \Gamma$. Factor Γ/M just represents the quality of the soft photon approximation.
- The case of charged resonance is more complicated because it also can emit photons.

Three possible approaches:

- Neglect interferences between production and decay completely (YFSWW3).
- Include them in soft photon approximation at $\mathcal{O}(\alpha^1)$ (RacoonWW).
- Include them in soft photon approximation to $\mathcal{O}(\alpha^\infty)$, i.e. exponentiate (done in KKMC for Z).
Here we show how to do it for WW .

All virtual and real emissions, in soft limit

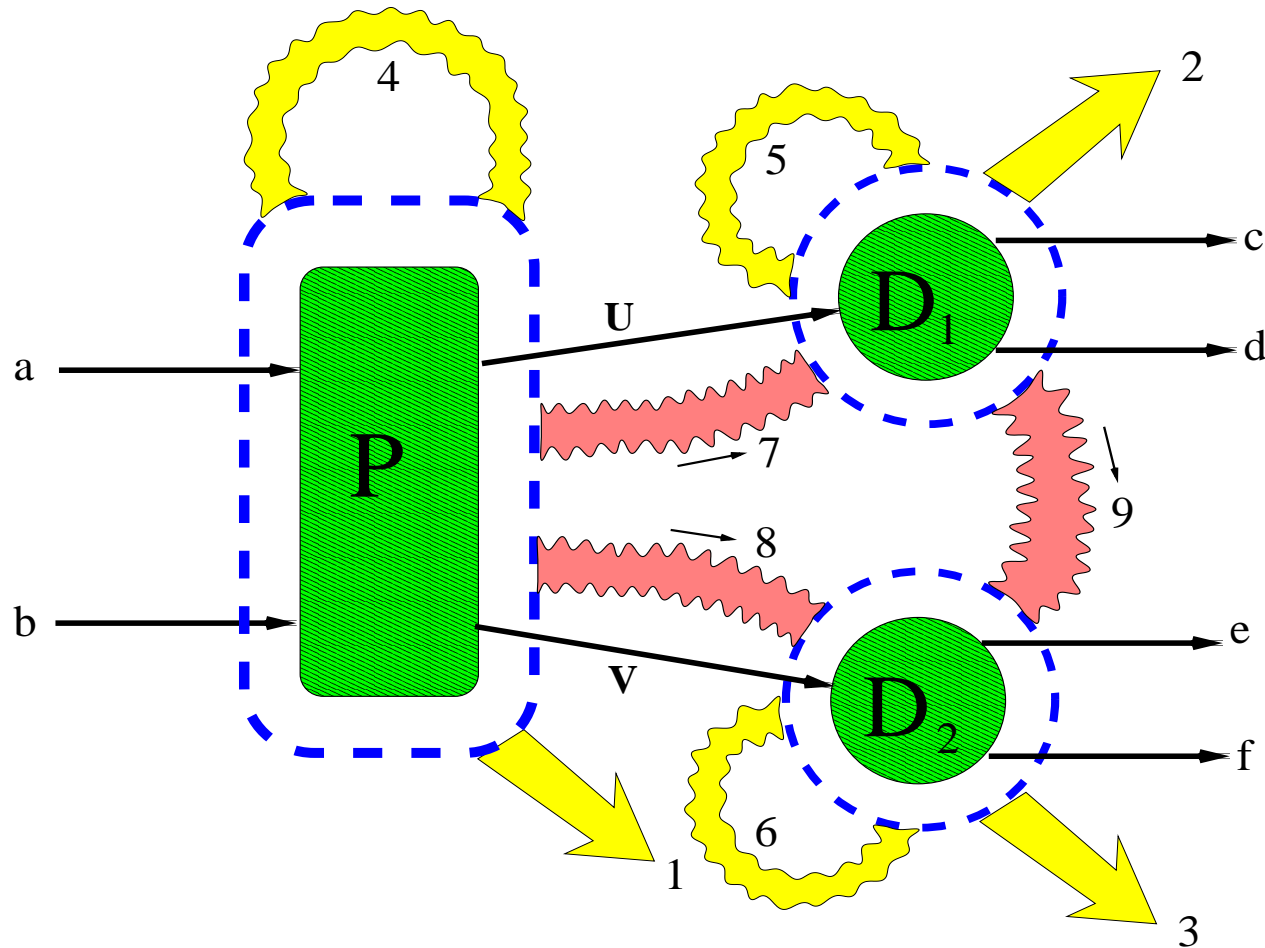

The complete exclusive (coherent) exponentiation for 2 charged resonances

Notation: EM real and virtual current

$$j^\mu(k) = ie \sum_{X=a,b,c,d,e,f} Q_X \theta_X \frac{2p_X^\mu}{2p_X k}$$

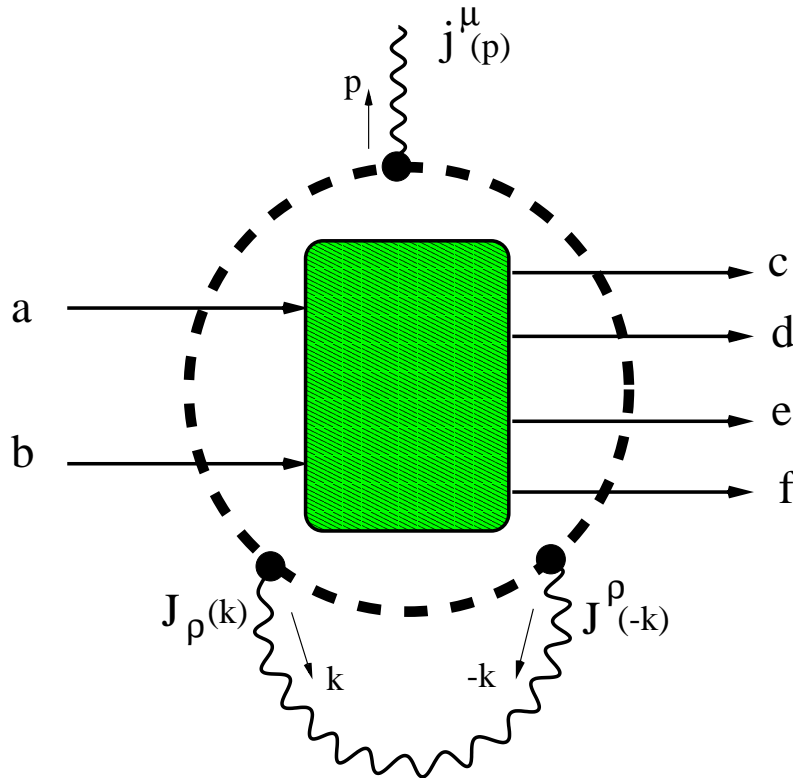

$$J^\mu(k) = \sum_{X=a,b,c,d,e,f} \hat{J}_X^\mu(k), \quad \hat{J}_X^\mu(k) \equiv Q_X \theta_X \frac{2p_X^\mu + k^\mu \theta_X}{k^2 + 2p_X k \theta_X + i\varepsilon}$$

Virtual lines are pair-contracted giving S -factors:

$$S(k) = J(k) \circ J(k) = \sum_{\substack{X=a,b,c,d,e,f \\ Y=a,b,c,d,e,f}} J_X(k) \circ J_Y(k),$$

where Q_X is charge, $\theta = +1, -1$ for initial, final state and

$$J_X(k) \circ J_Y(k) \equiv J_X(k) \cdot J_Y(-k), \quad \text{for } X \neq Y,$$

$$J_X(k) \circ J_X(k) \equiv J_X(k) \cdot J_X(k). \quad (\text{Exactly as in YFS61})$$

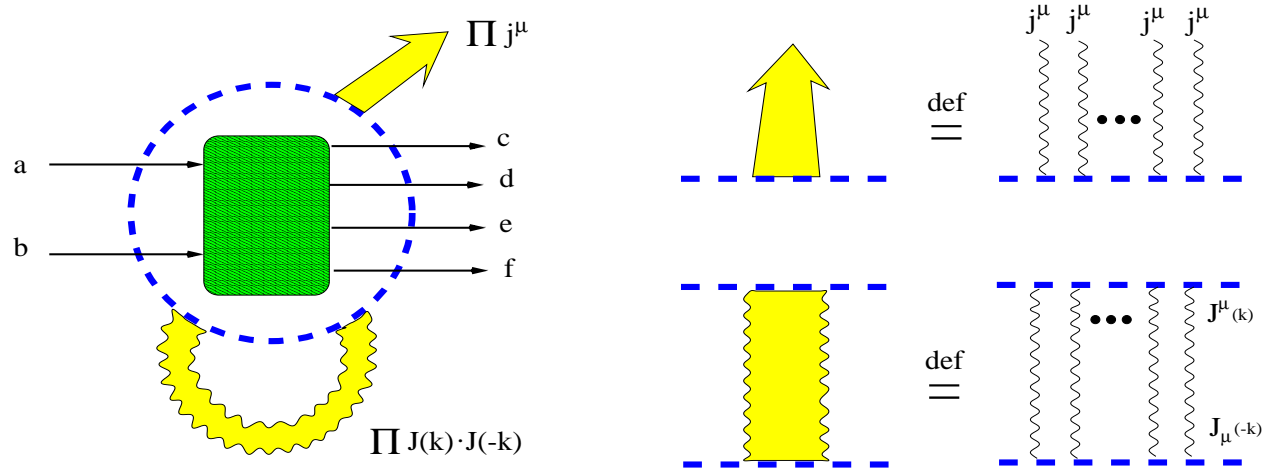
Warm up: Standard Yennie-Frautschi-Suura-1961, 6 external legs

$$\begin{aligned}
 M^{\mu_1 \mu_2 \dots \mu_m}(k_1, k_2, \dots, k_m) &= \\
 &= \mathcal{M} \prod_{l=1}^m j^{\mu}(k_l) \sum_{n=0}^{\infty} \frac{1}{n!} \prod_{i=1}^n \int \frac{i}{(2\pi)^3} \frac{d^4 k_i}{k_i^2 - \lambda^2 + i\epsilon} J^{\mu}(k_i) \circ J_{\mu}(k) \\
 &= \mathcal{M} \prod_{l=1}^m j^{\mu}(k_l) e^{\alpha B_6}, \\
 B_6 &= \int \frac{i}{(2\pi)^3} \frac{d^4 k}{k^2 - \lambda^2 + i\epsilon} J(k) \circ J(k).
 \end{aligned}$$

CEEEX for 2 narrow charged resonances

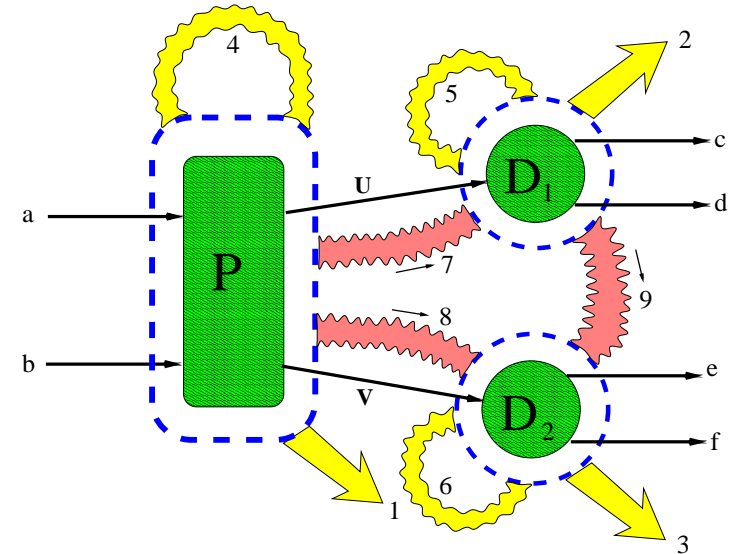

$$\begin{aligned}
 M^{\mu_1 \dots \mu_n}(k_1, k_2, \dots, k_n) &= \\
 &= \sum_{\wp \in (P, D_1, D_2)^n} \mathcal{M}_0 \prod_{i=1}^n j_{\wp_i}^{\mu_i}(k_i) e^{B_{10}^{\text{CEEEX}}(U_{\wp}, V_{\wp})} \frac{1}{U_{\wp}^2 - M^2} \frac{1}{V_{\wp}^2 - M^2},
 \end{aligned}$$

where

$$U_{\wp} = p_{cd} + \sum_{\wp_i = D_1} k_i, \quad V_{\wp} = p_{ef} + \sum_{\wp_i = D_2} k_i,$$

$$\alpha B_{10}^{\text{CEEEX}}(U, V) =$$

$$= \alpha B_P + \alpha B_{D_1} + \alpha B_{D_2} + \alpha B_{P \otimes D_1}(U) + \alpha B_{P \otimes D_2}(U) + \alpha B_{D_1 \otimes D_2}(U, V),$$

$$\alpha B_{P \otimes D_1}(U) = \int \frac{i}{(2\pi)^3} \frac{d^4 k}{k^2 - m_{\gamma}^2 + i\epsilon} J_P(k) \circ J_{D_1}(k) \frac{U^2 - M^2}{(U-k)^2 - M^2},$$

$$\alpha B_{P \otimes D_2}(U) = \int \frac{i}{(2\pi)^3} \frac{d^4 k}{k^2 - m_{\gamma}^2 + i\epsilon} J_P(k) \circ J_{D_2}(k) \frac{U^2 - M^2}{(U-k)^2 - M^2},$$

$$\alpha B_{D_1 \otimes D_2}(U, V) = \int \frac{i}{(2\pi)^3} \frac{d^4 k}{k^2 - m_{\gamma}^2 + i\epsilon} J_{D_1}(k) \circ J_{D_2}(k) \frac{U^2 - M^2}{(U+k)^2 - M^2} \frac{V^2 - M^2}{(V-k)^2 - M^2}.$$

Closer look at 1-real-photon case

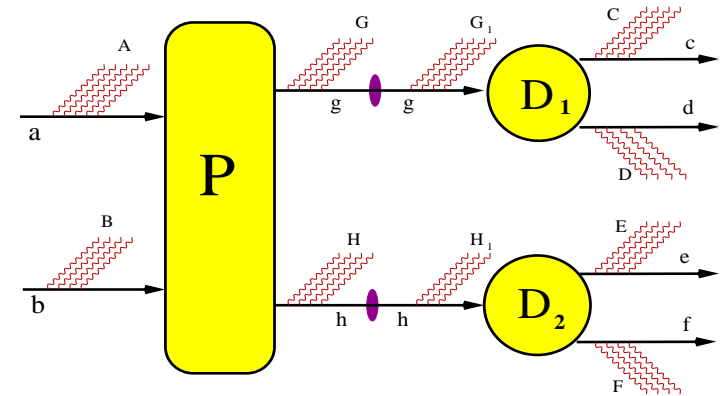

$$\begin{aligned}
 \mathcal{M}_1^{(0)\mu 1}(k) &\simeq \\
 &\frac{1}{p_{cd}^2 - M^2} \frac{1}{p_{ef}^2 - M^2} \left\{ Q_a \frac{2p_a^\mu}{2p_a k} + Q_b \frac{2p_b^\mu}{2p_b k} - Q_g \frac{2p_g^\mu}{2p_g k} - Q_h \frac{2p_h^\mu}{2p_h k} \right\} \\
 &+ \frac{1}{(p_{cd} + k)^2 - M^2} \frac{1}{p_{ef}^2 - M^2} \left\{ Q_g \frac{2p_g^\mu}{2p_g k} - Q_c \frac{2p_c^\mu}{2p_c k} - Q_d \frac{2p_d^\mu}{2p_d k} \right\} \\
 &+ \frac{1}{p_{cd}^2 - M^2} \frac{1}{(p_{ef} + k)^2 - M^2} \left\{ Q_h \frac{2p_h^\mu}{2p_h k} - Q_e \frac{2p_e^\mu}{2p_e k} - Q_f \frac{2p_f^\mu}{2p_f k} \right\} \\
 &= \frac{1}{p_{cd}^2 - M^2} \frac{1}{p_{ef}^2 - M^2} \left\{ j_P^\mu + \frac{p_{cd}^2 - M^2}{(p_{cd} + k)^2 - M^2} j_{D_1}^\mu + \frac{p_{ef}^2 - M^2}{(p_{ef} + k)^2 - M^2} j_{D_2}^\mu \right\}
 \end{aligned}$$

For $k^0 < \Gamma$: Normal YFS small limit, Emission from W 's cancels out!

For $k^0 > \Gamma$: Each Intermediade W is present twice (4+3+3=10 sources),

Energy shift in W propagator properly coherently accounted for,

Three gauge-invariant corrects for production and 2 decays.

$\mathcal{O}(\alpha^1)_{\text{CEEX}}$ with **incomplete** $\mathcal{O}(\alpha\Gamma_W/M_W)$

$$\mathcal{M}_n^{(1)\mu_1, \mu_2, \dots, \mu_n}(k_1, k_2, \dots, k_n) = \sum_{\wp \in \{P, D_1, D_2\}^n} e^{\alpha B_{10}^{\text{CEEX}}(U_\wp, V_\wp)} \times \left\{ \hat{\beta}_0^{(1)}(U_\wp, V_\wp) \prod_{i=1}^n j_{\{\wp_i\}}^{\mu_i}(k_i) + \sum_{j=1}^n \hat{\beta}_{1\{\wp_j\}}^{(1)\mu_j}(U_\wp, V_\wp, k_j) \prod_{i \neq j} j_{\{\wp_i\}}^{\mu_i}(k_i) \right\}$$

IR-finite $\hat{\beta}$'s from $\mathcal{O}(\alpha^1)$ Feynman diagram calculations (without NF):

$$\hat{\beta}_0^{(1)}(U, V) = \left[e^{-\alpha B_{10}^{\text{F}act}(U, V)} M_0^{(1)}(U, V) \right]_{\mathcal{O}(\alpha^1)} = M_0^{(1)}(U, V) - B_{10}^{\text{F}act}(U, V),$$

where $B_{10}^{\text{F}act}(s_1, s_2) = \alpha B_P + \alpha B_{D_1} + \alpha B_{D_2}$,

$$\hat{\beta}_{1\{\pi\}}^{(1)\mu}(U_\pi, V_\pi, k) = M_{1\{\pi\}}^{(1)\mu}(U_\pi, V_\pi, k) - j_\pi^\mu(k) M_0^{(0)}(U_\pi, V_\pi), \quad \pi = P, D_1, D_2.$$

IR cancellation occur automatically after phase space integration:

$$\sigma = \sum_{n=0}^{\infty} \frac{1}{n!} \int_{m_\gamma} d\Phi_{4+n}(k_1 \dots k_n) \sum_{spin} |e^{\alpha B_{10}(m_\gamma)} \mathfrak{M}_n(k_1 \dots k_n)|^2.$$

Non-factorisable (NF) included in the soft-photon approximation (as in all existing calculations in the literature); good enough for differential distributions (disregarding normalization).

This is Double-Pole (DP) component, Single-Pole (SP) $\mathcal{O}(\Gamma_W/M_W)$ next slide

$\mathcal{O}(\Gamma_W/M_W)$ Single-Pole $\mathcal{O}(\alpha^0)_{\text{CEEX}}$

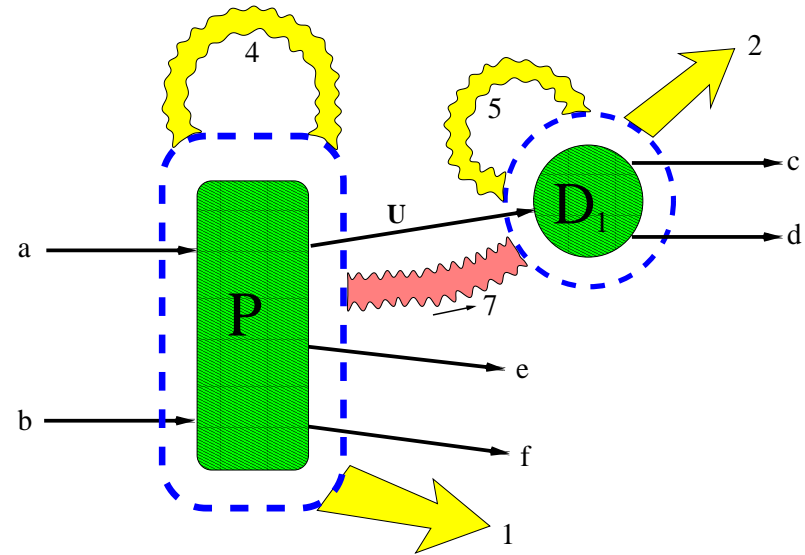

$$\mathcal{M}_n^{(0)\mu_1, \mu_2, \dots, \mu_n}(k_1, k_2, \dots, k_n) = \sum_{\wp \in \{P, D_1\}^n} e^{\alpha B_8^{\text{CEEX}}(U_\wp)} \hat{\beta}_0^{(0)}(U_\wp) \prod_{i=1}^n j_{\{\wp_i\}}^{\mu_i}(k_i)$$

Here $\hat{\beta}_0^{(0)}(U)$ is **Single-Pole component of Born**.

DP at $\mathcal{O}(\alpha^1)_{\text{CEEX}}$ and SP at $\mathcal{O}(\alpha^0)_{\text{CEEX}}$ to be added coherently!

The Real Challenge: $\mathcal{O}(\alpha^1)_{\text{CEEX}}$ with **complete $\mathcal{O}(\alpha\Gamma_W/M_W)$**

- It makes practical sense with the $\mathcal{O}(\alpha^2)$ for the DP part,
- plus $\mathcal{O}((\Gamma_W/M_W)^2)$ at the Born level ($\mathcal{O}(\alpha^0)_{\text{CEEX}}$), trivial.
- $\mathcal{O}(\alpha^1)$ for $e^-e^+ \rightarrow 4f$ is necessary as a raw material, with explicit split into DP+SP.
- Ordinary ISR up to $\mathcal{O}(\alpha^3)$ LL, (also $\mathcal{O}(\alpha^2)$ NLL ??)

The overall precision tag $\sim 10^{-4}$. Needs 10^6 WW-pairs.

Derivation of EEX of YFSWW3 from new CEEX

Only one essential step: Neglect interference between production and decays in

$$\begin{aligned} \sigma^{\text{CEEX}} &= \frac{1}{flux} \sum_{n=0}^{\infty} \frac{1}{n!} \int dLips_{4+n}(p_a + p_b; p_c, p_d, p_e, p_f, k_1 \dots k_n) \\ &\times \sum_{\varphi \in \{P, D_1, D_2\}^n} e^{\alpha B_{10}^{\text{CEEX}}(U_\varphi, V_\varphi)} \\ &\times \left\{ \hat{\beta}_0^{(1)}(U_\varphi, V_\varphi) \prod_{i=1}^n j_{\{\varphi_i\}}^{\mu_i}(k_i) + \sum_{j=1}^n \hat{\beta}_{1\{\varphi_j\}}^{(1)\mu_j}(U_\varphi, V_\varphi, k_j) \prod_{i \neq j} j_{\{\varphi_i\}}^{\mu_i}(k_i) \right\} \\ &\times \sum_{\varphi' \in \{P, D_1, D_2\}^n} e^{\alpha B_{10}^{\text{CEEX}*}(U_{\varphi'}, V_{\varphi'})} \\ &\times \left\{ \hat{\beta}_0^{(1)}(U_{\varphi'}, V_{\varphi'}) \prod_{i=1}^n j_{\{\varphi'_i\}}^{\mu_i}(k_i) + \sum_{j=1}^n \hat{\beta}_{1\{\varphi'_j\}}^{(1)\mu_j}(U_{\varphi'}, V_{\varphi'}, k_j) \prod_{i \neq j} j_{\{\varphi'_i\}}^{\mu_i}(k_i) \right\}^* \end{aligned}$$

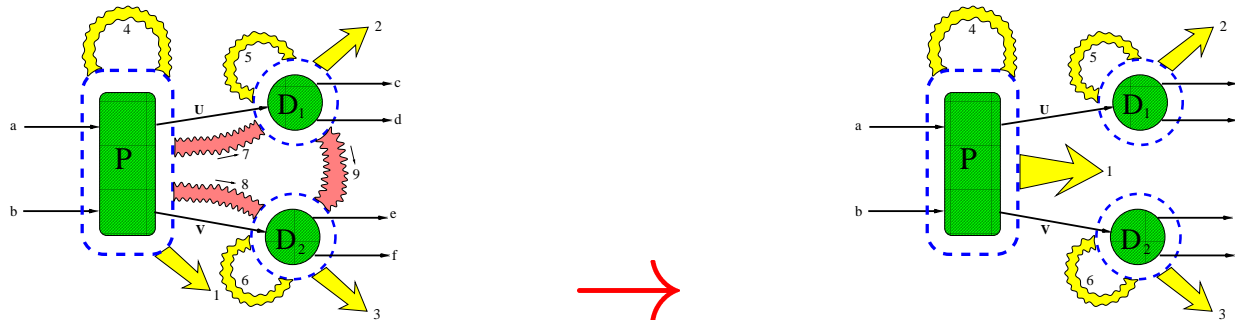

Neglect interference terms $\varphi \neq \varphi'$ and in $\alpha B_{10}^{\text{CEEX}} \rightarrow \alpha B_{10}^{\text{EEX}}$

Derivation of EEX of YFSWW3 from new CEEX

$$\sigma^{\text{CEEX}} \rightarrow \sigma^{\text{EEX}} = \frac{1}{\text{flux}} \sum_{n=0}^{\infty} \frac{1}{n!} \int dLips_{4+n}(p_a + p_b; p_c, p_d, p_e, p_f, k_1 \dots k_n)$$

$$\times \sum_{\wp \in \{P, D_1, D_2\}^n} e^{2\alpha \Re B_P + 2\alpha \Re B_{D_1} + 2\alpha \Re B_{D_2}} \prod_{i=1}^n |j_{\{\wp_i\}}^{\mu_i}(k_i)|^2$$

$$\times \left\{ |\hat{\beta}_0^{(1)}(U_\wp, V_\wp)|^2 + \sum_{j=1}^n \frac{2\Re(\hat{\beta}_{1\{\wp_j\}}^{(1)}(U_\wp, V_\wp, k_j) \cdot j_{\{\wp_j\}}(k_j)^*) + |\hat{\beta}_{1\{\wp_j\}}^{(1)}(U_\wp, V_\wp, k_j)|^2}{|j_{\{\wp_j\}}(k_j)|^2} \right\}$$

Using Bose symmetry it can be brought to traditional EEX (YFS-1961) form:

$$\sigma^{\text{EEX}} = \sum_{n_0=0}^{\infty} \sum_{n_1=0}^{\infty} \sum_{n_2=0}^{\infty} \int dLips_{4+n_0+n_1+n_2}(p_a + p_b; p_c, p_d, p_e, p_f, k_1 \dots k_{n_2})$$

$$\times \frac{1}{n_0!} \prod_{i_1=0}^{n_0} \tilde{S}_P(k_{i_0}) \frac{1}{n_1!} \prod_{i_1=1}^{n_1} \tilde{S}_{D_1}(k_{i_1}) \frac{1}{n_2!} \prod_{i_2=1}^{n_2} \tilde{S}_{D_2}(k_{i_2})$$

$$\times e^{2\alpha \Re B_P + 2\alpha \Re B_{D_1} + 2\alpha \Re B_{D_2}} \left\{ \bar{\beta}_0^{(1)}(U, V) \right.$$

$$\left. + \sum_{j=1}^{n_0} \frac{\bar{\beta}_{1\{P\}}^{(1)}(U, V, k_j)}{\tilde{S}_P(k_j)} + \sum_{j=1}^{n_1} \frac{\bar{\beta}_{1\{D_1\}}^{(1)}(U, V, k_j)}{\tilde{S}_{D_1}(k_j)} + \sum_{j=1}^{n_2} \frac{\bar{\beta}_{1\{D_2\}}^{(1)}(U, V, k_j)}{\tilde{S}_{D_2}(k_j)} \right\},$$

where $U = p_{cd} + \sum_{i_1=0}^{n_1} k_{i_1}$ and $V = p_{ef} + \sum_{i_2=0}^{n_2} k_{i_2}$.

Three independent EEX, one for production and two decays.

SUMMARY

- Nontrivial $\mathcal{O}(\alpha^1)$ seen in WW process at LEP2 and agree with the SM calculation of YFSWW3 and RacoonWW.
- Interferences between production and two decays can be implemented for fully inclusive differential distributions to infinite order.
- $\mathcal{O}(\alpha\Gamma/M)$ -complete calculation plus $\mathcal{O}(\alpha^2)$ Double-Pole is a challenge for the future.

People:

- Kraków: S. Jadach, M. Jezabek M. Skrzypek, W. Pł aczek, Z. Wąs, E. Richter- Wąs.
- Katowice: M. Zrał ek, K. Koł odziej
- Warszawa: J. Kalinowski, M. Krawczyk

Examples of inter-node activity:

- Krakow-Zeuthen, $\nu\bar{\nu}\gamma$ process
- Katowice-Zeuthen, WW process
- Warsaw-Hamburg, SUSY models

Current works:

- MC programs for LEP/TESLA: WW, $\nu\bar{\nu}\gamma$, Bhabha, $t\bar{t}$
- Massive neutrinos
- SUSY models at LHC
- and more...